

The "LET YOUR HAIR DOWN"

Column

WE are pleased to record in this column that on the 20th of last month the Chamber Offices were transferred from the premises at No. 424 San Luis Street, occupied since February of 1952, to the Bay-side wing, ground floor, of the handsome Elks Club Building on the Luneta, only a few blocks down the street from the former location.

While we of the Chamber and Journal staffs have all been quite comfortable in the fine building owned by Judge Jose C. Zulueta, to whom we are beholden for many courtesies during the past several years, the new location brings a number of advantages, including an increase in floor space from some 200 square meters to nearly 300. The place is conveniently reached by car and

there is plenty of parking space, too. The general area is one of the most beautiful in all Manila.

Mr. Stanley N. Fisher, the new Executive Vice-President of the Chamber, has a private office of his own, and the *Journal* editor's office is larger than the one he occupied in the former quarters. All the others of us are comfortably placed and everyone during the first few days mentioned the fine, fresh air from the Bay and the Luneta.

Everyone is pleased with the Chamber Board for having put the matter through.

There is talk now of holding some sort of "house-warming" for the Chamber members and guests, but the plans for this have not yet been completed. However, as from now, everyone is welcome to drop in for a visit any time.

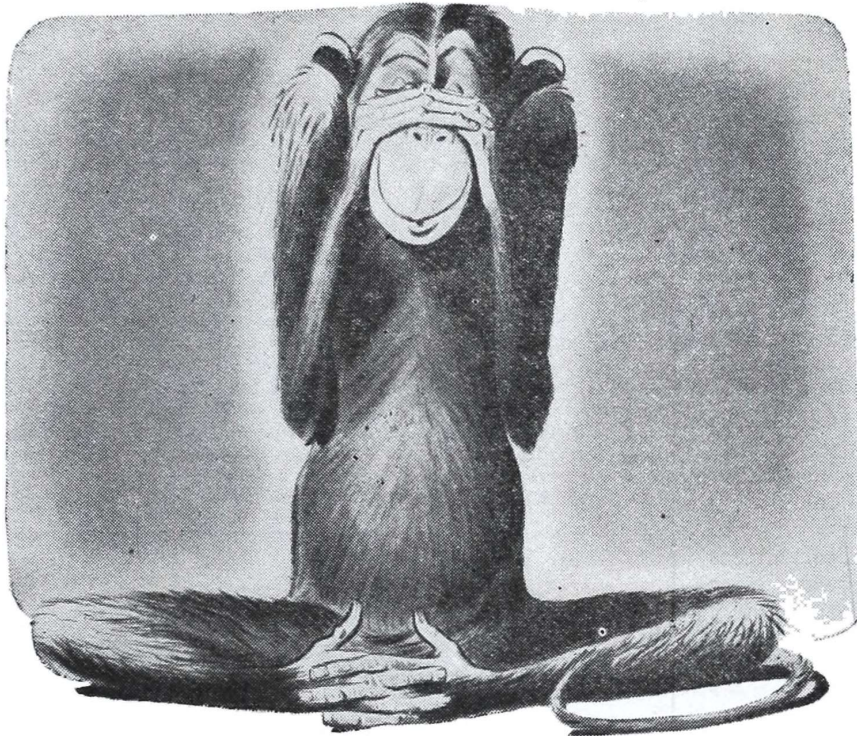

No "blind spot" on weight indications?

ask

Fairbanks-Morse

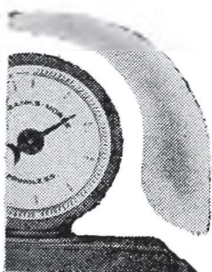

Fairbanks-Morse knows better than anyone else that a dependable scale mechanism is only one part of accurate weighing.

The rest? Minimizing the human element!

Fairbanks-Morse Scale Engineers created the Direct Reading Dial... virtually a dial behind a dial... that eliminates the chance for human reading errors. Regardless of the number of drop weights applied, weights are always read at the point of the indicator. As each drop weight is applied, the inner chart revolves,

automatically changing the figures on the chart. No need for mental calculations... no need to add to the reading on the chart... no possibility of making a mistake.

Starting in 1830 with the historic invention of the lever system which makes modern weighing practical, Fairbanks-Morse has consistently led in major scale developments, including the latest electronic weighing equipment. That's why, in every industry, in every land, Fairbanks-Morse Scales are known and respected.

Fairbanks, Morse & Co., Inc., Export Division,
80 Broad Street, New York 4, N. Y., U.S.A.

Established
in 1830



FAIRBANKS-MORSE

a name worth remembering when you want the best

OVER a period of time there is always an accumulation of back issues of any publication and usually these are disposed of to old-paper dealers at a very low price per pound or kilo. In the case of the *Journal*, there are never very many copies left over in excess of the number we regularly keep in stock for some years, but some do accumulate over a period of a year or so and then, instead of getting rid of the excess

EVERETT

STEAMSHIP CORPORATION

Owners-Brokers-Agents

Manila

155 Juan Luna St., Tel. 2-79-31

General Agencies

AMERICAN MAIL LINE

To and From

Portland	Seattle
Vancouver	Tacoma
Japan	Philippines
Straits	Indonesia

PACIFIC TRANSPORT LINES

To and From

California-Japan-Philippines

BARBER-FERN-VILLE LINES

To U.S. Atlantic

Via Straits, Suez, Mediterranean

FERN-VILLE FAR EAST LINES

To and From

North Atlantic Ports

Gulf Ports-Philippines

Via Panama

MESSAGERIES MARITIMES

To and From

Europe and Mediterranean Ports

EVERETT ORIENT LINE

Between

Philippines, China, Japan

Korea, Straits, and India Ports

EVERETT STAR LINE

Between

Japan, China, Straits, India,

and Persian Gulf Ports

PHILIPPINE STEAM NAVIGATION CO.

Serving the Philippine Islands

UNITED STATES SALVAGE ASSOCIATION

UNITAS OSLO

THAI AIRWAYS

To and From

Bangkok, Singora, Singapore

Hongkong, Taipeh, Okinawa, and Japan

to an old-paper dealer, we write the public school authorities to ask whether they would like to have the old *Journals* for the teachers and school libraries. Shortly before transferring our quarters from 424 San Luis Street to the Elks Club Building we again wrote such a letter to Director Venancio Trinidad, of the Bureau of Public Schools, and received from him the following reply:

"I have your letter of July 6, and it is a pleasure to know that you are again planning to send us your excess copies of past issues of the *Journal*. We shall distribute to our secondary schools any number of copies you can send us. I am happy to learn that you are moving to more spacious quarters which, I hope, will mean a better and greater *Journal*. Thank you very much for your kind offer."

As for us, we are happy to know that the school authorities like to receive even back issues of the *Journal*. Much of the material contained in them is, of course, no longer of much or any value to ordinary readers, but some of the special articles and editorials on general topics are probably of more or less permanent interest. And for the historical record, of course, the whole *Journal* is of importance especially if the annual volumes are kept complete.

The *Journal* as a collectors' item came up in a letter from Mr. E. A. Perkins received by the editor this month. It read:

"The Japanese played havoc with my back issues of the American Chamber of Commerce *Journal*. With the outbreak of the war, I had everything practically complete up to 1941. Since then I have not been so careful in retaining my copies. As a consequence there are a number of missing copies which I would like to obtain in order to reestablish my set complete. They are as follows:

- 1923— Vol. 2—all.
- January, 1937, to December, 1945—all.
- 1946— January, March, May, June, November, December.
- 1947— all.
- 1948— all.
- 1949— January, February, March, April, May, July, August, September, October, November, December.

- 1950— January, February, March, April, May, August, September, October, November, December.
- 1951— February, March, April, May.

"I have in mind to place an advertisement in the American Chamber of Commerce *Journal* and offer to purchase a good clean back number of any of the above. However, before doing so, please let me know if you have any of them in stock, with the amount, and I will send my messenger to receive and pay for them.

"When you are in Baguio, please make it a point to call at No. 8 South Drive and see my Filipiniana collection which I have housed here. At the present time I have over 5,000 titles. Very sincerely, etc."

Mr. Perkins has a far more complete set of the pre-war issues of the *Journal* than we have here at the Office, but we had duplicate copies

• DUMP YOUR TRAVEL WORRIES OVERBOARD!

for carefree travel at its best... consult



"Your travel agent in the Orient"

• TRAVEL COUNSELORS •
 BOOKING AGENTS for all airlines
 217 Dasmarinas, Manila • Tel. 2-69-56



ALLIS-CHALMERS

MACHINERY for the Economical Processing of Ore and Rock Products

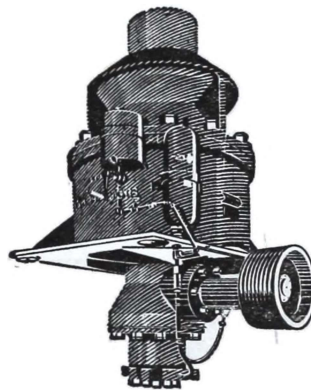

***HYDROCONE CRUSHER**

Highly efficient for fine crushing. Has hydraulic control for quick, accurate setting and automatic protection against damage from uncrushable material.

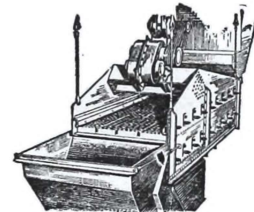

SCREENS—Eight basic types, in many sizes. We can help you select the correct screen for any purpose.

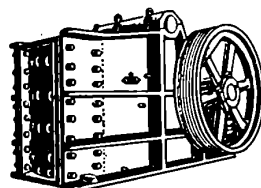

JAW CRUSHER

A machine of highest quality and large capacity for crushing of tough, abrasive materials.

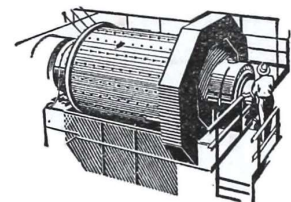

GRINDING MILLS—Ball and rod mills, single and multi-stage units in a full range of types and sizes.

*Hydrocone is an Allis-Chalmers trademark

Exclusive Distributors:

THE EARNSHAW DOCKS & HONOLULU IRON WORKS

Main Office: Cor. TACOMA & 2nd STS., PORT AREA, MANILA • TEL. 3-35-41
 Branch Offices at: BACOLOD CITY • CEBU CITY • P. O. BOX 282

of eleven issues published during the years 1938, 1939, and 1941 which we could let him have. We could also furnish him with all the post-war issues he wanted except those for December, 1947, and May, 1951, which issues are now out of stock.

As the publication of the *Journal* was very irregular following the first post-war issue, that of December, 1945, and up to the issue for July, 1947, the first gotten out under the present editorship, we refer interested persons to the "Note for Librarians", published in that July issue, which lists all the numbers gotten out during that period,—only ten issues in all: December, 1945; February, April, July, August, September-October, November, and December, 1945; and February and April, 1947.

Index to Advertisers

	Page
Allied Brokerage Corp.....	362
American Steamship Agencies.....	361
Atlantic, Gulf & Pacific Co.....	366
Columbian Rope Co. of Philippines.....	362
Earnshaws Docks & HIW.....	365
Elser, E. E., Inc.....	358
Engineering Equipment & Supply Co.....	352
Erlanger & Galinger, Inc.....	359
Everett Steamship Corp.....	364
Fairbanks, Morse Co.....	364
Getz Bros. & Co., Inc.....	363
Goodyear Tire & Rubber Co.....	Back Cover
Heilbronn, J. P. Co.....	357
Highland Shop, The.....	349
Insular Lumber Co.....	353
International Harvester Co.....	Inside Back Cover
Koppel (Philippines) Inc.....	359
Luzon Brokerage Co.....	356
Luzon Stevedoring Co.....	360
Mandalay, Inc.....	340
Manila Electric Co.....	333
McCullough Printing Co.....	357
Metropolitan Investigative Agency, Inc.....	361
Motoi Service Co.....	359
National City Bank.....	350
Neuss, Hesselein & Co.....	360
Pacific Far East Lines, Inc.....	361
Pacific Merchandising Corp.....	355
Pasig River Bodegas.....	361
Philippine Education Co.....	358
Philippine Manufacturing Co.....	351
Picornell, Ortigas & Co.....	360
Security Delivery Service.....	356
Sharp & Co., Inc., C. F.....	365
Shell Co. of P. I., Ltd.....	341
Smith Bell Co., Ltd.....	354
Standard-Vacuum Oil Co.....	Inside Front Cover
United States Tobacco Corp.....	358

PRE-FABRICATED IN THE PHILIPPINES

**STANDARDIZED
RIGID-FRAME
MULTI-PURPOSE
BUILDINGS**

For:

**FACTORIES
SCHOOLS
WAREHOUSES
STORAGE-SHEDS**

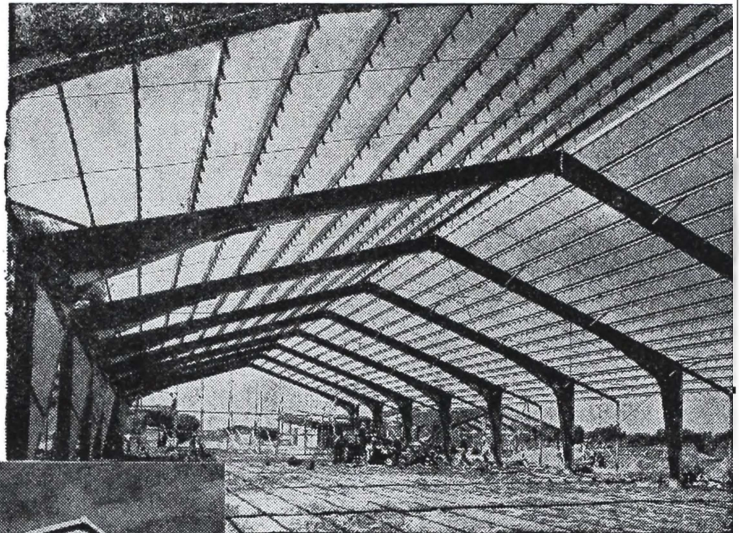

The grade school cafeteria and the auditorium of the Ateneo de Manila have 70-ft. spans.

Designed and Fabricated in the Philippines by AG&P

Take advantage of our selection of standardized pre-fabricated buildings which can be offered as "packages" at special prices.

We have a selection of sizes which can cover your requirements.

"Know-How" Plus Experience Since 1905

**Atlantic, Gulf & Pacific Co.
of Manila**

**ENGINEERS * CONTRACTORS
MANUFACTURERS * DISTRIBUTORS**

*Merchandise Sales Division
Robert Dollar Bldg., Port Area, Manila
Tel. 3-36-61 (Connecting all Depts.)*

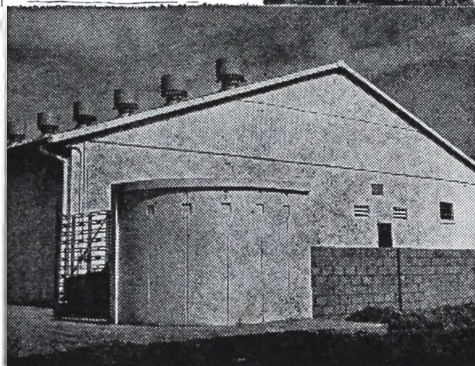

The steel warehouse of E. R. Squibb & Sons, fabricated and erected by AG&P.

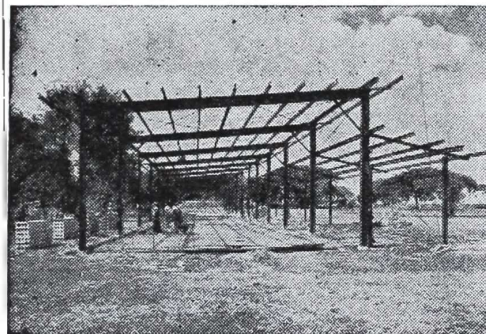

The shop buildings of the U. E. Technical School, each with 40-ft. rafter spans.

*Executive Offices • Engineering Div.
Structural & Machine Shops
Barrio Punta, Sta. Ana, Manila—Tel. 6-75-31*

The United States subscription rate to the *Journal* sent by ordinary mail for one year, is \$5.00.

For \$13.00 a year the Journal Office will send monthly any selected page-clipping by air-mail in addition to sending the whole issue, as usual, by ordinary mail.